

**Simulation of Pair of 150MHz Thick Folded Dipole
Using WIPL-D 3D EM Solver**

Internal Technical Report

November 2008

B. Hanumanth Rao

G. Sankar

**Gaint Meterwave Radio Telescope
National Center for Radio Astrophysics
Tata Institute of Fundamental Research
Narayangoan**

Abstract

This report describes the design, construction and characterization of a low frequency feed of GMRT antennas, covering the Astronomical band of 150 MHz using WIPL-D 3D EM Solver Software.

Introduction

1.1 General

The Giant Metrewave Radio Telescope (GMRT) consists of an array of 30 antennas. Each antenna is 45 m in diameter, and has been designed to operate at a range of frequencies from 50 MHz to 1450 MHz. The antennas have been constructed using a novel technique (nicknamed SMART) and their reflecting surface consists of panels of wire mesh. This panel is attached to rope trusses, and by appropriate tensioning of the wires used for attachment the desired parabolic shape is achieved. This design has very low wind loading, as well as a very low total weight for each antenna. Consequently it was possible to build the entire array very economically.

1.2 Feed Design Aspects

The unique feature of the boxing ring configuration is that it has more symmetric radiation characteristics (E and H plane patterns) than a single dipole like feed. Here one pair of dipole, combined as an adding type array provides sensitivity to one linear polarization and another pair orthogonally oriented with respect to the first pair give sensitivity to the other polarization state.

A two-element array with a spacing of $\lambda/2$ gives an H plane pattern, which is very similar to the E-plane pattern. So it is appropriate to design the boxing ring with this dimension at the resonant frequency.

This feed employs four dipoles in a "boxing ring" configuration, placed above a plane reflector. The unique feature of the dipole is that it is wide-band i.e. has an octave bandwidth. It is a folded dipole with each arm being a "thick" dipole. A dipole is called 'thin' when its diameter, $d > 0.05 \lambda$. For such dipoles a sinusoidal current distribution can be assumed for the computation of input impedance and related radiation parameters.

Thin dipoles have narrowband impedance characteristics. One method by which its acceptable operational bandwidth can be increased is to decrease the l/d ratio.

For example, an antenna with an $l/d \sim 5000$ has an acceptable bandwidth of about 3%, while an antenna of the same length but with an $l/d \sim 260$ has a bandwidth of about 30%. By folding the dipole, one gets a four-fold increase in input impedance compared to a simple dipole. The 150 MHz feed also has a transmission line impedance transformer coupled to the excitation point.

Traditionally crossed-dipoles are used to give sensitivity to both polarizations. However since a crossed-dipole configuration in this design would be extremely cumbersome, a "boxing ring" design was instead chosen. Here one pair of dipoles at $\lambda/2$ spacing provides sensitivity to one linear polarization. Another pair orthogonally oriented with respect to the first pair gives sensitivity to the orthogonal polarization. The overall dimensions of the feed are:

- Folded dipole length : $0.39 \lambda = 780$ mm
- Dipole height above reflector : $0.29 \lambda = 600$ mm
- Reflector (diagonal of octagon) : $1.2 \lambda = 2400$ mm

The dipoles have an l/d ratio of **6.48**, and the phase center was determined to be at a height of 100 mm above the reflector.

The usable bandwidth for a feed is given approximately by the range for which $SWR \leq 2.0$. The radiation pattern gives an edge taper, $T_E = -9$ dB.

One undesirable feature of this feed is the high value of cross-polarization, as compared to that at other frequencies. The cross-polar peak for 150 MHz. is **-17 dB** and the on-axis cross polarization is also at about the same level.

One-pair of outputs from the dipoles which are parallel to each other are connected to a power-combiner, whose output goes to one port of the quadrature hybrid (which adds two linear polarized signals to yield one circular polarized signal). Similarly the orthogonal pair of dipole is connected to the other port of the hybrid. Both the power combiners and the quadrature hybrid are mounted inside one of the front-end chassis, placed behind the feed.

Steps involved in the Design and Simulation of thick Folded Dipole in WIPL-D 3D EM solver

1. Open a new Project in WIPL-D 3D EM solver.



2. Set Frequency range, 100-300 MHz.
3. Set the operation mode (i.e., one generator or all generators at a time) for excitation.
4. Set θ and Φ values and the number of directions to see required output results (i.e, near field pattern, far field pattern etc).
5. Use BoR (Body of Revolution) to get outline as Thick Folded Dipole

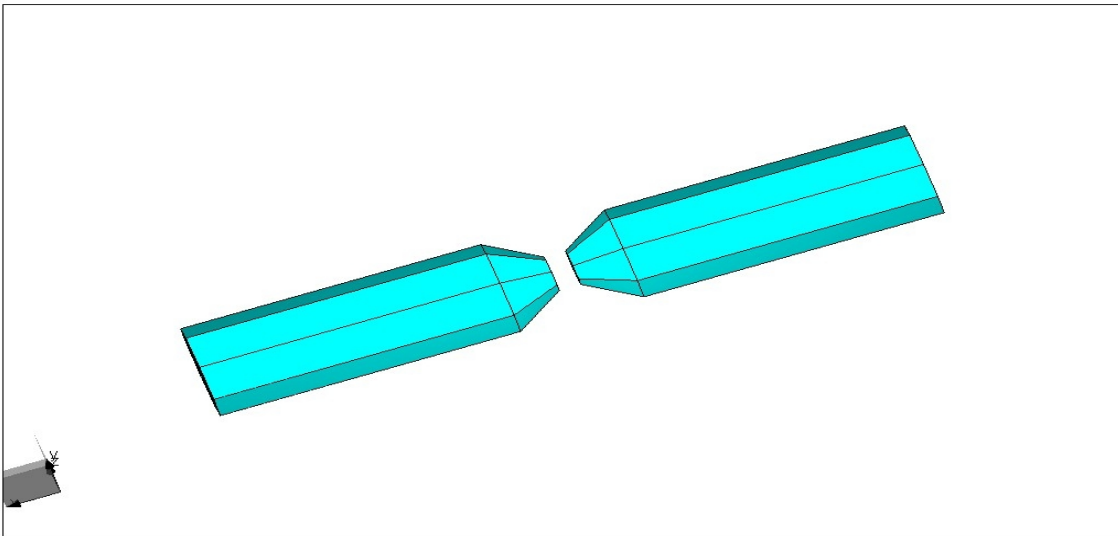

- Place wire before placing generator (note: We can't place generator without wire) for excitation.

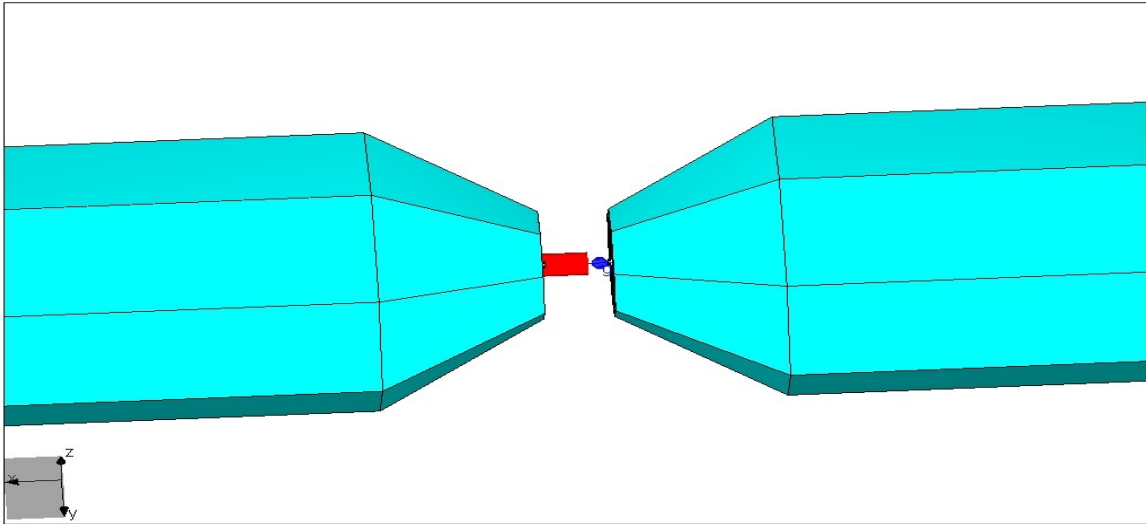

- Add Junction on either side of the wire to get connected with the surface of dipole.
- Repeat the Steps 5, 6 and 7 to get one more folded dipole and separate with $\lambda/2$ distance.

pair of 150MHz Folded Dipole

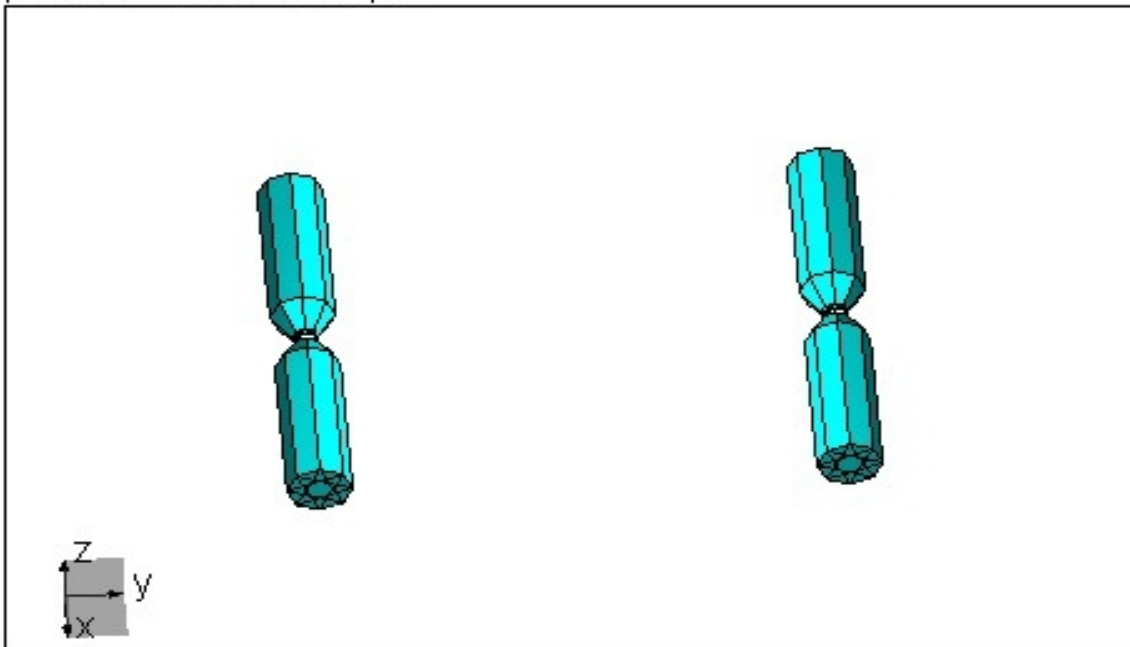

Separated by a distance $\lambda/2$

9. Go to option called Object and get a Reflector whose radius should be 1.2λ in mm and place it below the pair of dipole at a distance 2.9λ in mm.

Pair of 150MHz Folded Dipole with reflector

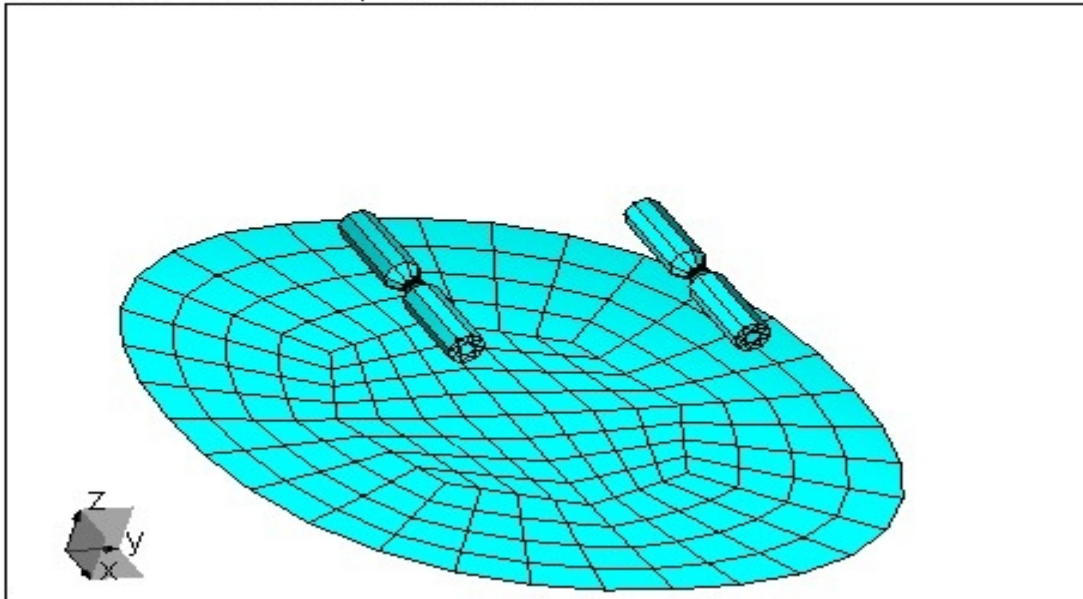

10. Execute and Analyze the Results.

Further Work:

Explore the option to build a BALUN in-conjunction with pair of dipole in WIPL-D 3D EM Solver, to improve the electrical characteristics like, VSWR and Return Loss. Concise way of depicting the polarization behaviour will be attempted.

Conclusion:

Simulated E and H patterns are exactly matching with Measured Radiation patterns which were taken at 150 MHz and 190 MHz, as shown in Fig-13, Fig-14, Fig-15 and Fig-16.

References:

1. G. Sankar, GMRT Antennas and Feeds (chapter-19), "Low Frequency Radio Astronomy ", 3rd Edition.
2. Guillou.L., Daniel.J-P., Terret.C., Madani.A., " Rayonnement d'un Doublet Replie Epais", Annales des Telecommunications, tome 30, nr 1-2. 1975.

Results:

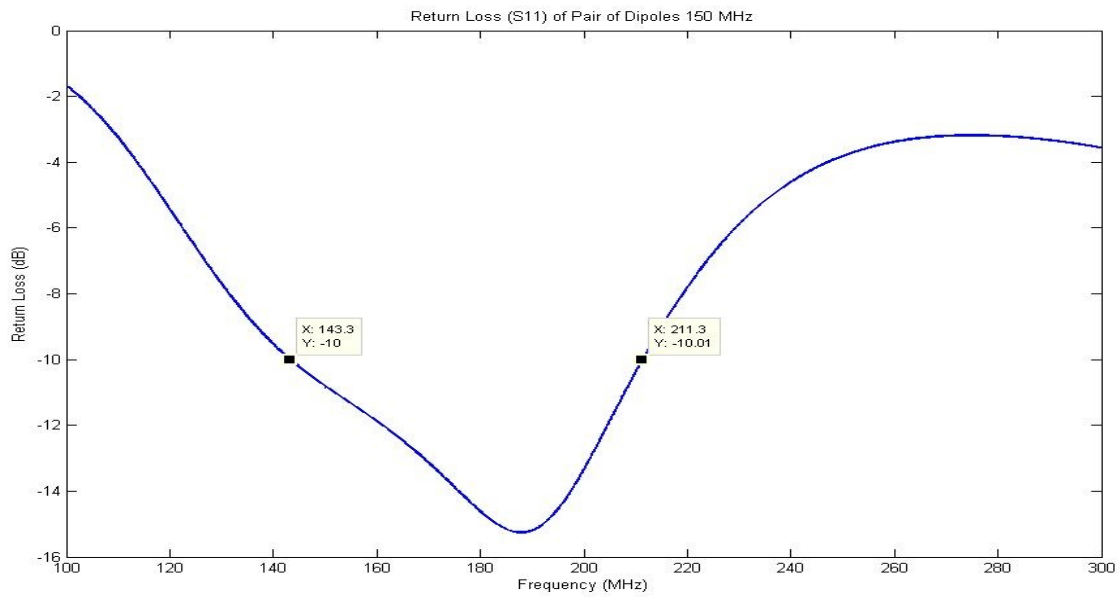

Fig-1: Return Loss (S11) Curve without BALUN

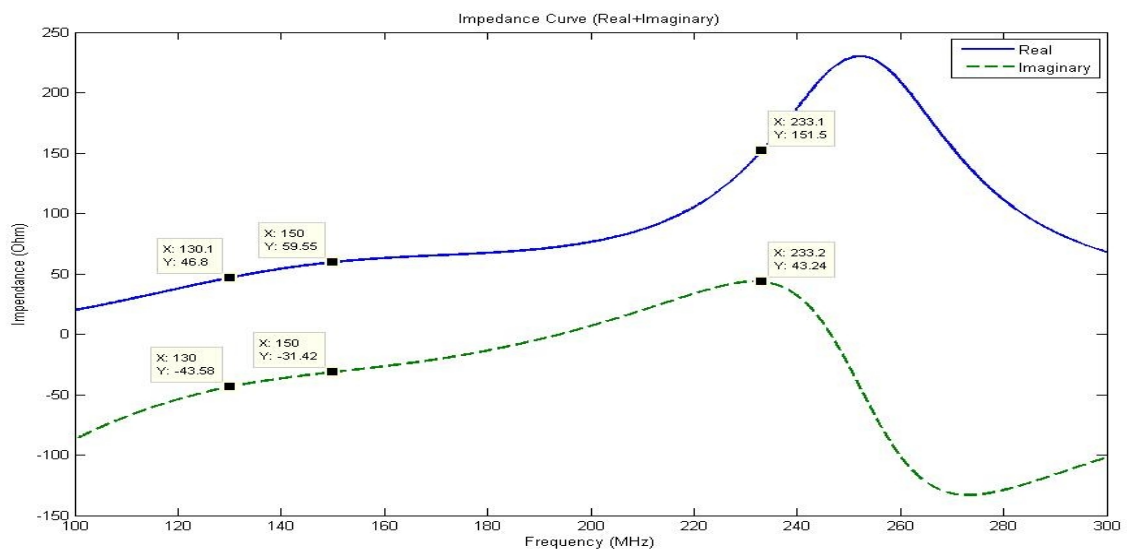

Fig-2: Impedance (Z) Curve without BALUN

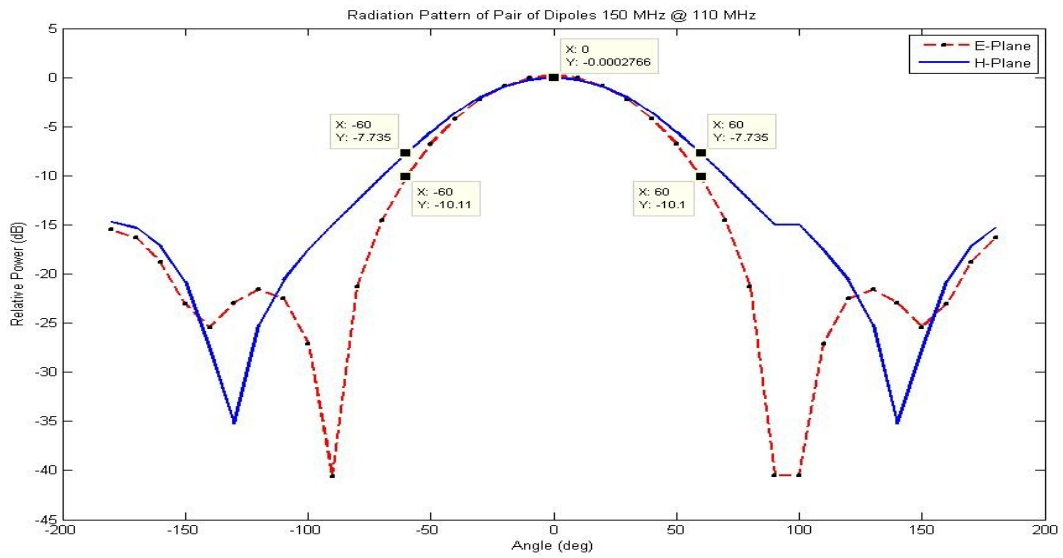

Fig-3: Radiation Pattern @ 110 MHz

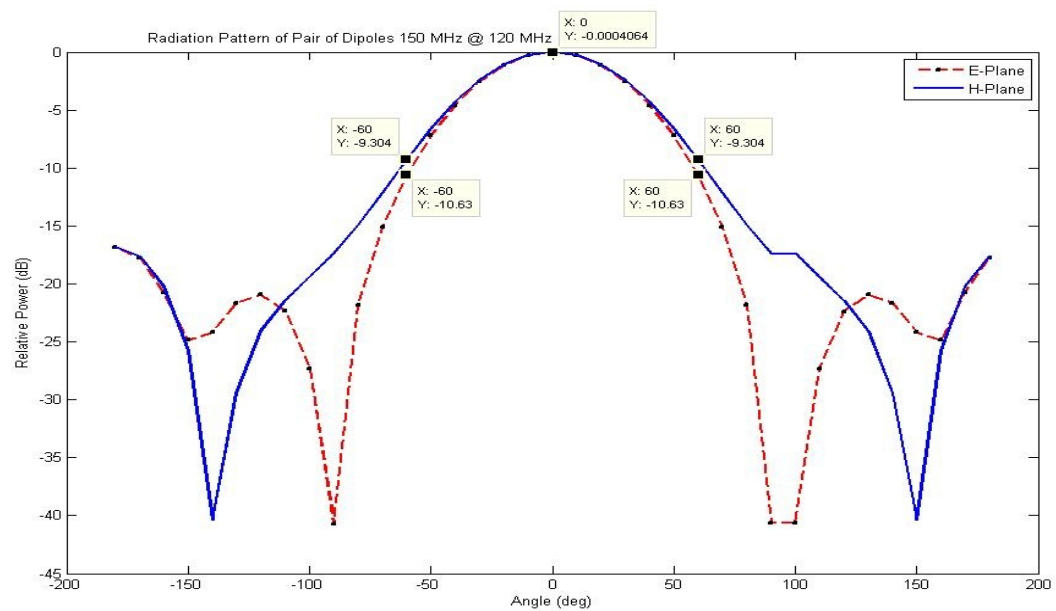

Fig-4: Radiation Pattern @ 120 MHz

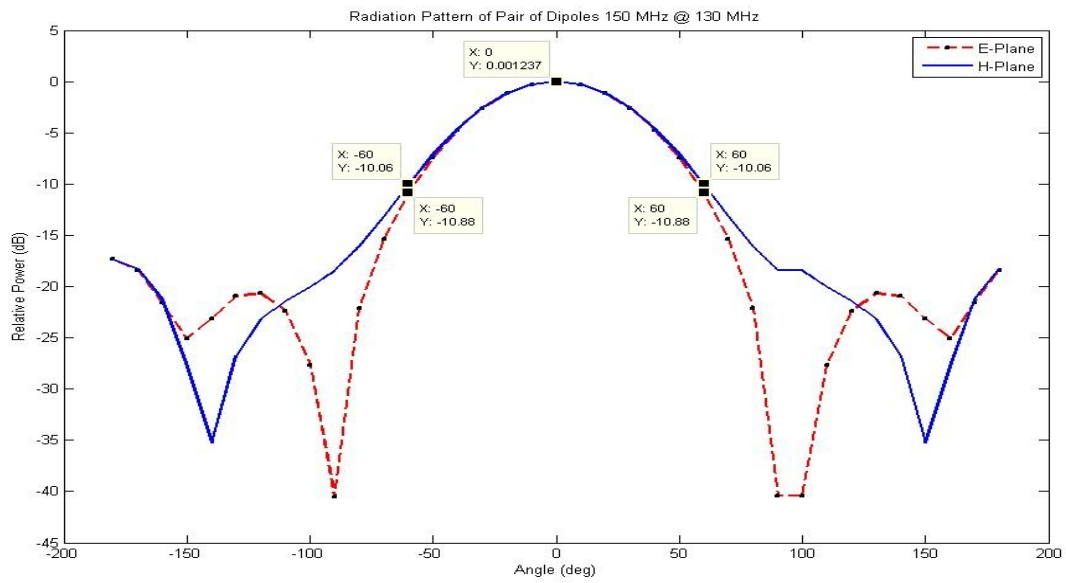

Fig-5: Radiation Pattern @ 130 MHz

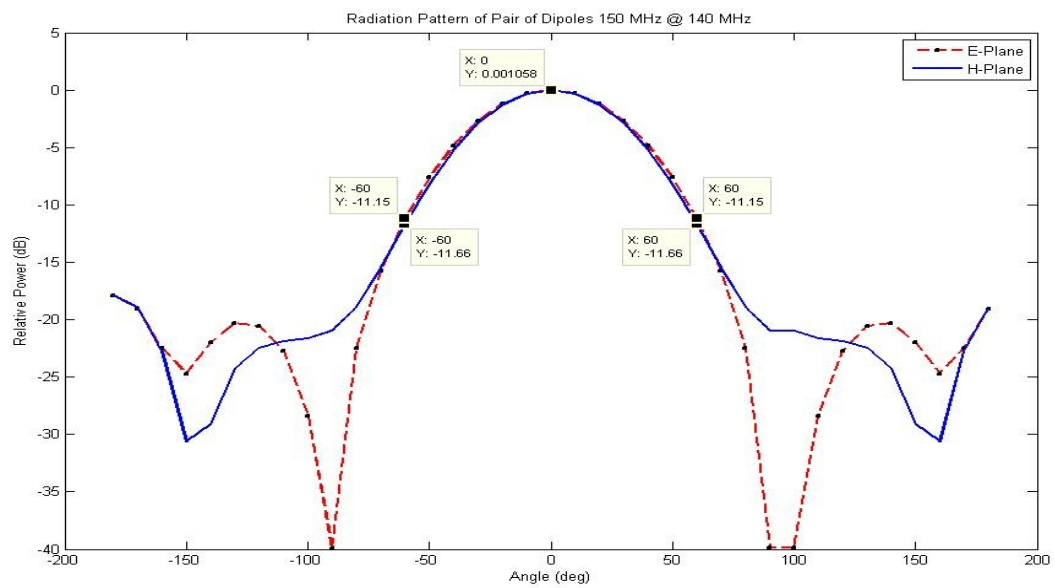

Fig-6: Radiation Pattern @ 140 MHz

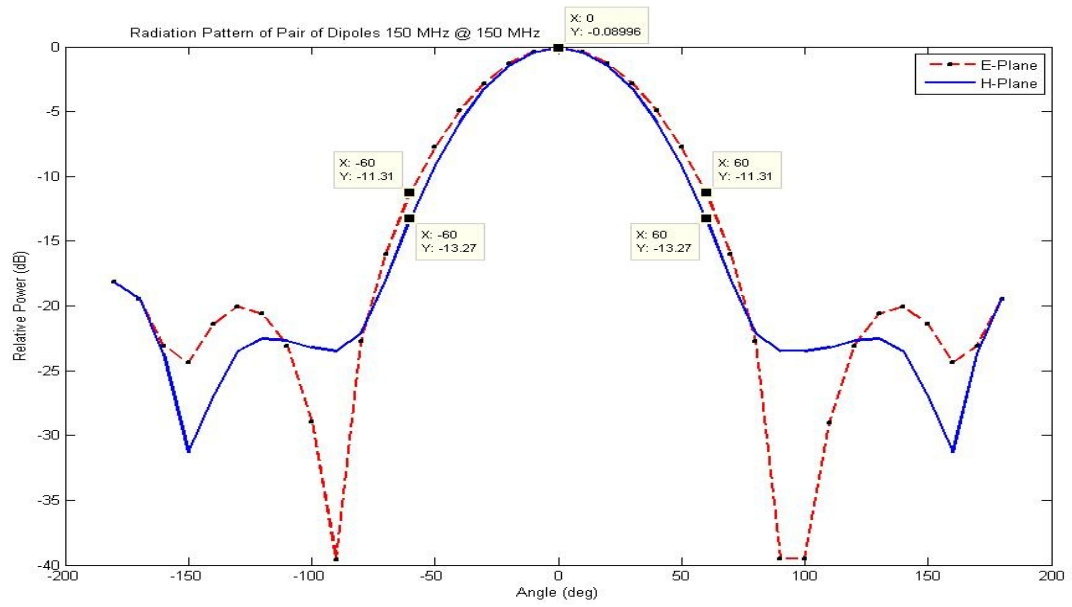

Fig-7: Radiation Pattern @ 150 MHz

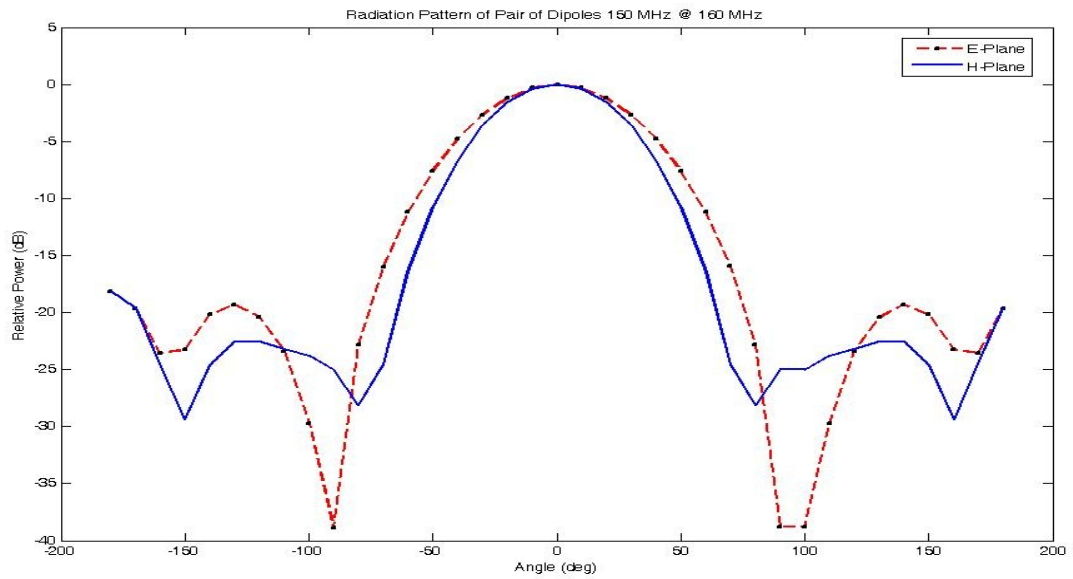

Fig-8: Radiation Pattern @ 160 MHz

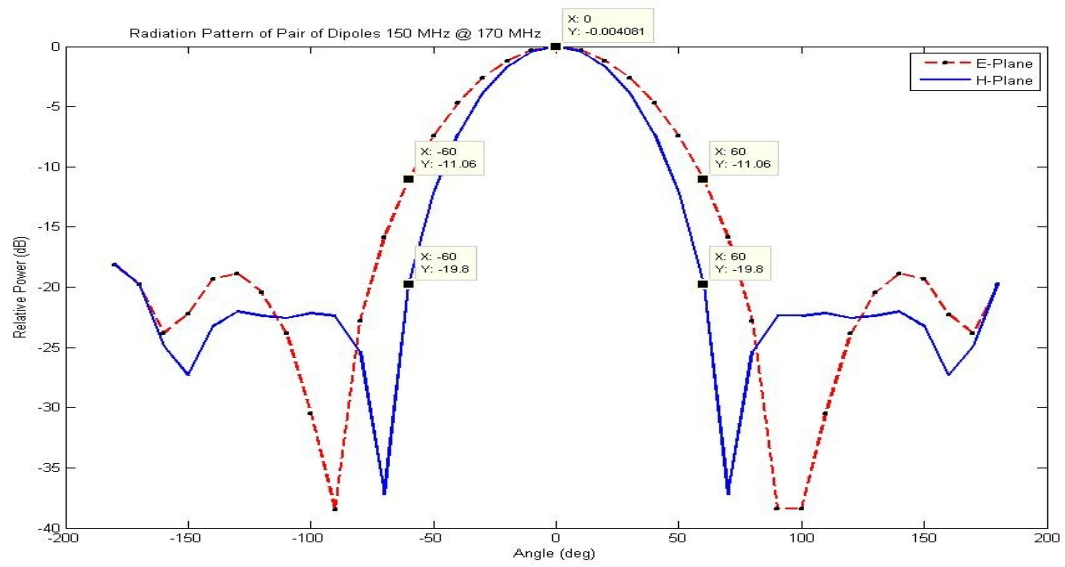

Fig-9: Radiation Pattern @ 170 MHz

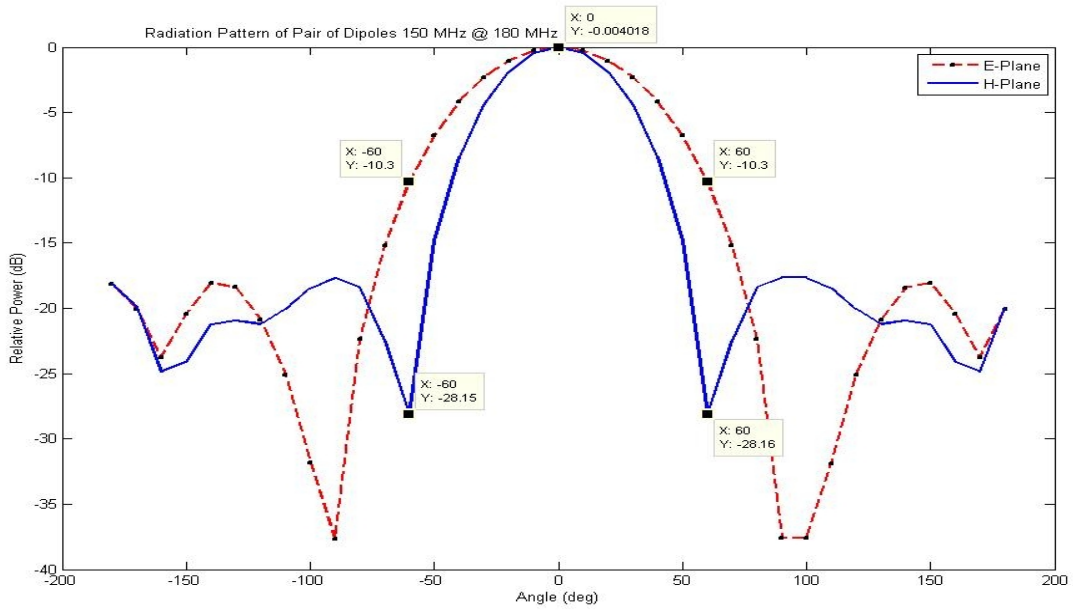

Fig-10: Radiation Pattern @ 180 MHz

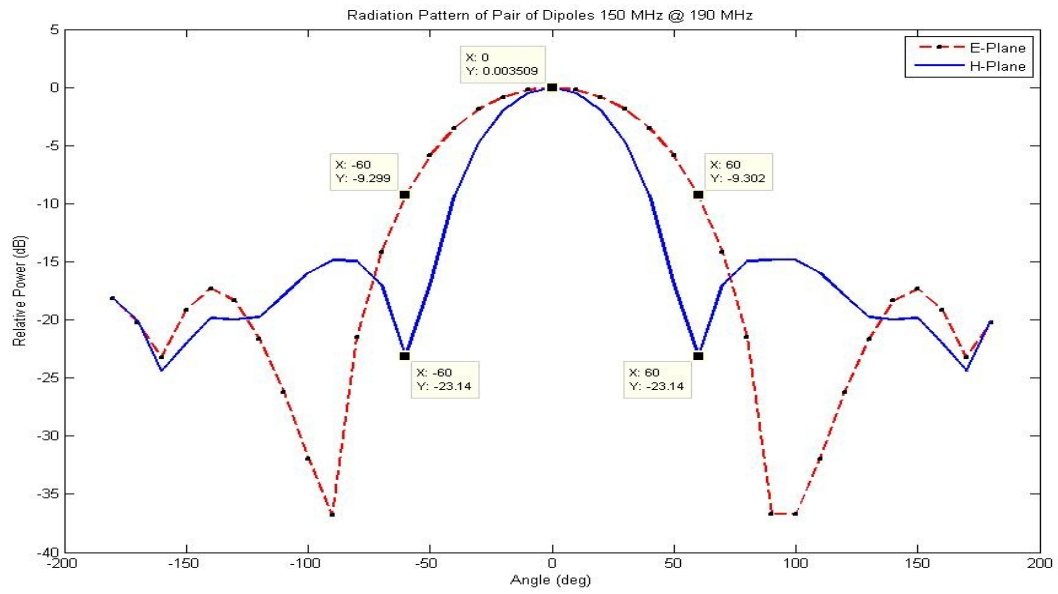

Fig-11: Radiation Pattern @ 190 MHz

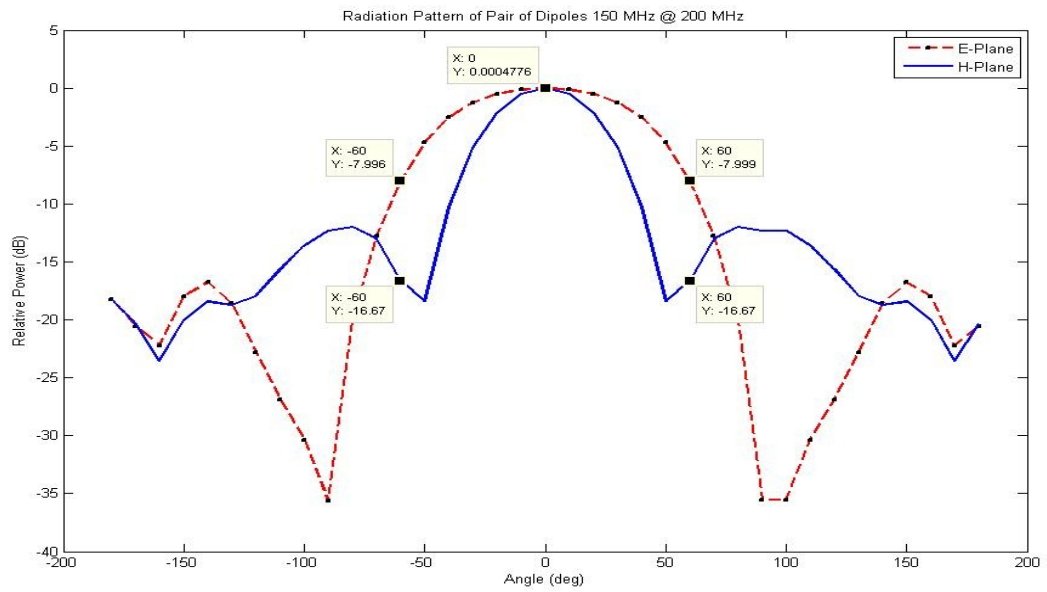

Fig-12: Radiation Pattern @ 200 MHz

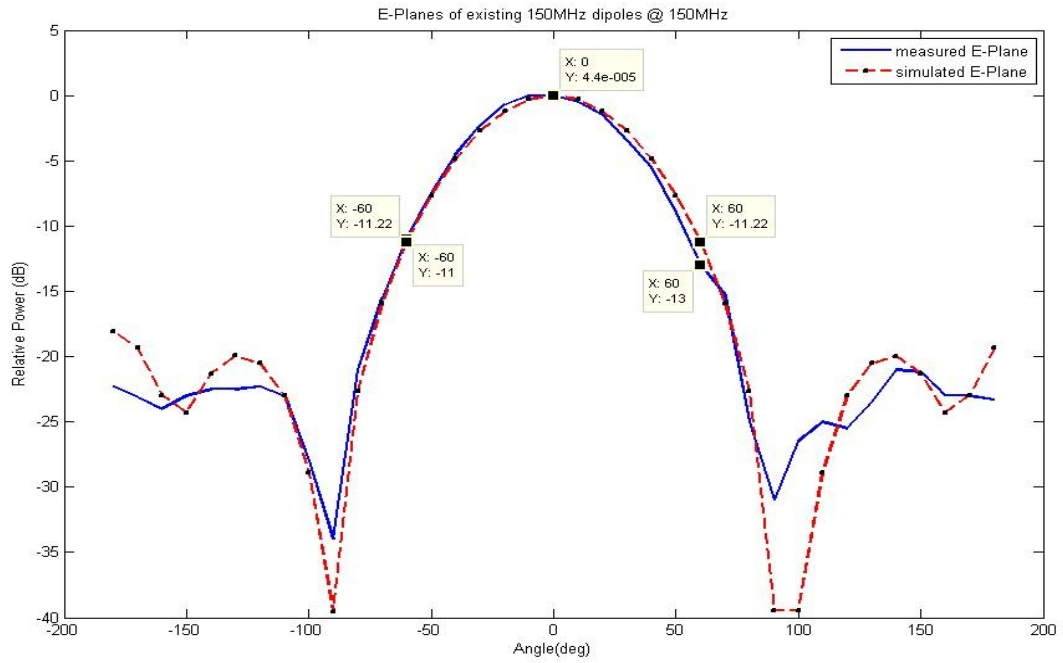

Fig-13: Simulated and Measured E-Plane Patterns @ 150 MHz

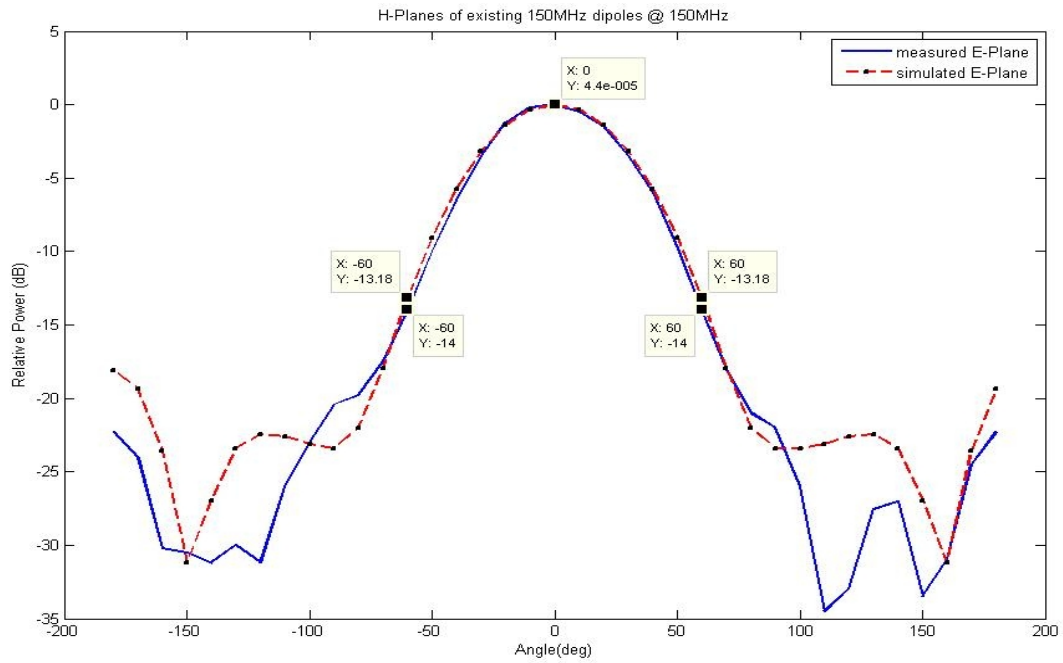

Fig-14: Simulated and Measured H-Plane Patterns @ 150 MHz

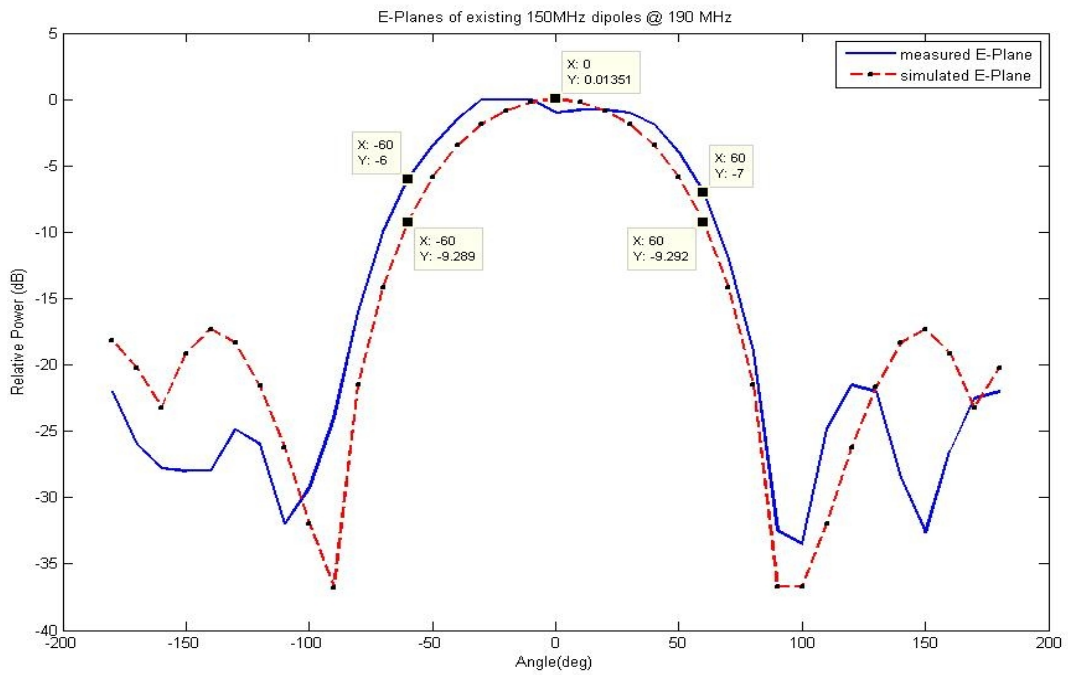

Fig-15: Simulated and Measured E-Plane Patterns @ 190 MHz

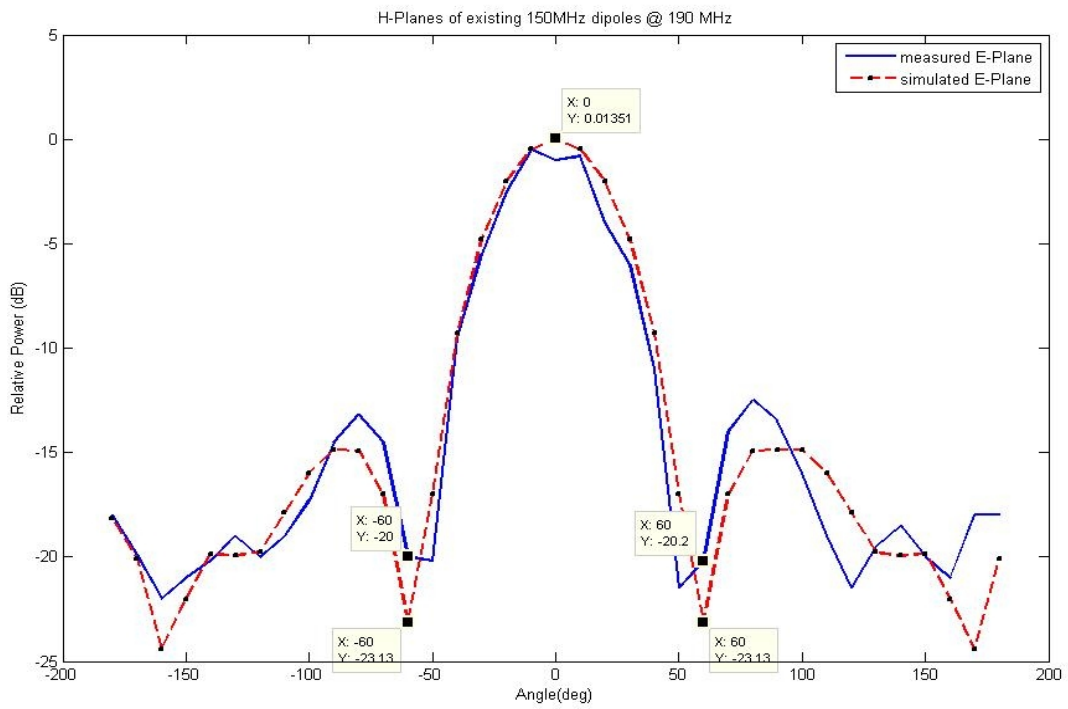

Fig-16: Simulated and Measured H-Plane Patterns @ 190 MHz

